



rammount.com
1.800.499.7479
support@rammount.com

RAM® Handlebar U-Bolt Base for Rails 0.5" to 1.25" in Diameter

Part Index

*not to scale

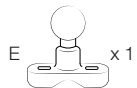
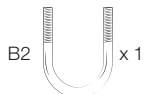
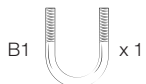

* Small U-Bolt supports rails .5" – 1"
Large U-Bolt supports rails 1" – 1.25"

For best results a 7/16" or 11mm box wrench is recommended

- 1** Determine what size U-Bolt (B) you will need for the mounting location and place over the rail. The optional spacer (D) might need to be inserted in the bottom hoop of the U-Bolt for smaller rails, to protect the rail surface, or to offset the excess threads on the U-Bolt from interfering with the ball mount.
- 2** Thread the RAM® Handlebar base (E) onto the U-Bolt and gradually tighten both nuts (A) evenly until secure on the rail. Check stability and tighten further as needed. Place rubber caps over excess threads if room allows.

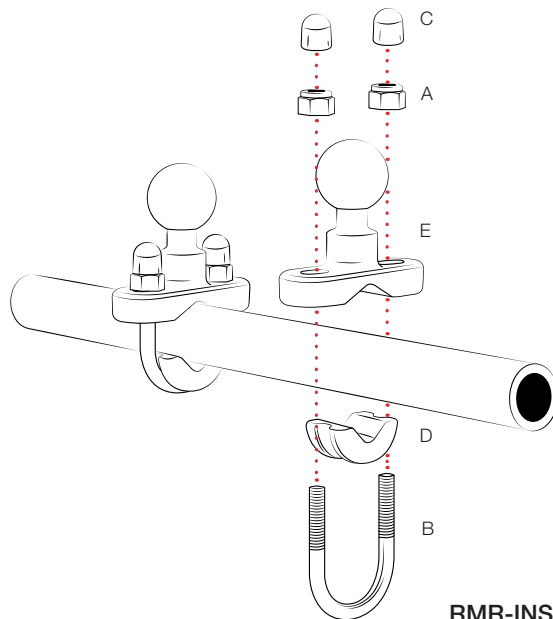

RMR-INS-B-231Z



Safety Precaution

Do not install this product near or over an airbag deployment area or in a location that obstructs the driver's vision or interferes with vehicle operation. National Products, Inc does not assume responsibility or liability for any such personal injury, death or property damage.